

FRONT VIEW

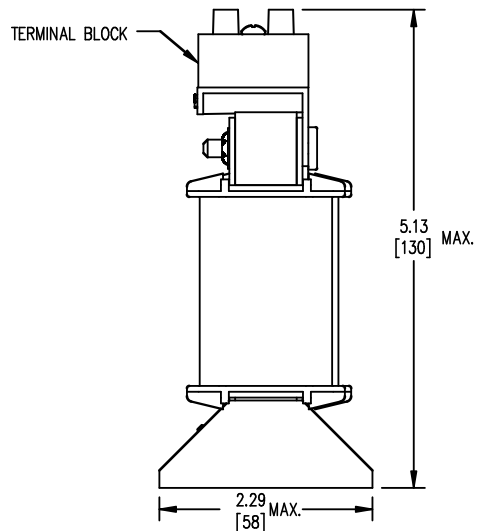

SIDE VIEW

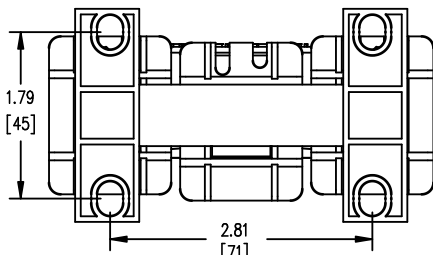

BOTTOM VIEW

TERMINAL BLOCK
SUITABLE FOR
#14 TO #18 AWG
CONDUCTORS
QTY. 1 PER PHASE

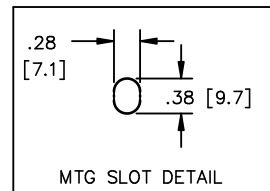

MTG SLOT DETAIL



TOLERANCES
MOUNTING CENTERS = +/- .06"
MOUNTING HOLE SIZE = +/- .005"

THIS DRAWING CONTAINS PROPRIETARY INFORMATION
BELONGING TO DELTA TRANSFORMERS,
AND IS NOT FOR GENERAL DISTRIBUTION

All Dimensions in Inches
mm in Parenthesis

REACTOR



3 PHASE DRY TYPE REACTOR
DELTA NOVA
DTX01D4BC

f003781.edt

33.9MH50/60 HZ 1.4 AMPS

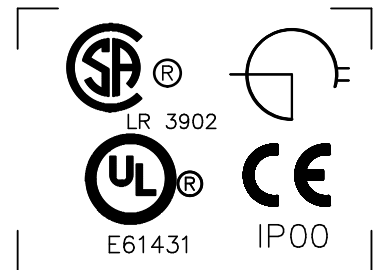

0.6 KV CLASS TEMP CLASS: 130 TYPE JR-1
TERMINAL TORQUE: 5 LB-IN AMBIENT: 50°C

NOTES:

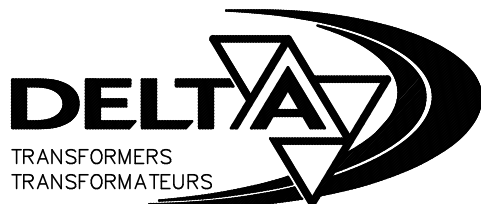

TITLE: 3 PHASE LINE REACTOR

DES:	JWEN
DATE:	16/02/10
SCALE:	NTS

SHEET 1 OF 1

EDBDTX01D4BC

0.1_wen 18/03/10